

2021 SMP Packages I, II, III, IV, V, & VI

Sirahuen Guajardo Jr., P.E.

Project Engineer

Efrain Aguirre, Graduate Eng II

Pipelines - Governmental

Florinda Gonzales

Interim Contract Administrator

Stella Manzello

Contract Administrator

Susan Rodriguez

SMWVB Program Specialist

Bryan Spina, P.E.

Project Engineer of Record

Greg Blackburn, P.E.

Project Engineer of Record

Chris Boentges, P.E.

Project Engineer of Record

Joseph Marranzino, P.E.

Project Engineer of Record



**San
Antonio
Water
System**

Non- Mandatory Pre-Bid Meeting

August 14, 2020

MAKING SAN ANTONIO
WATERFUL



Oral Statements

Oral statements or discussion during the pre-bid meeting today will not be binding, nor will it change or affect the terms or conditions within the Plans and Specifications of these Projects. Changes, if any, will be addressed in writing only via an Addendum.

Agenda

- General Information
- Small, Minority, Woman, and Veteran-Owned Business (SMWVVB Requirements)
- Contract Solicitation Website – Recent Changes
- Vendor Registration
- Key Reminders
- IFB Schedule
- Bid Packet Preparation
- Contract Requirements
- Project Overview
- Statement of Bidder's Experience
- Special Conditions
- Supplemental Conditions
- Project Details

General Information

- This is a Non-Mandatory pre-bid meeting
- This presentation and the attendance sheet will be posted to the SAWS website
- Construction services being procured through IFB

General Information

	2021 SMP Package I (Buckwheat, Sunny Glen, Mider)	2021 SMP Package II (Guadalajara, Minuteman, Village Haven)	2021 SMP Package III (Gorman St, Wyoming St, Paul St, NW 20th St)
Construction Estimate	\$1,825,181.85	\$1,636,075.52	\$1,884,852.94
Contract Duration	300 Days	300 Days	300 Days
	2021 SMP Package IV (Neff Ave., Rena Dr., Rouse, Topaz St.)	2021 SMP Package V (Hilary Rd, Delaware, Whitefield)	2021 SMP Package VI (Hale, Kernan Dr., Hoover Ave.)
Construction Estimate	\$1,361,475.26	\$1,976,384.26	\$1,679,177.31
Contract Duration	270 Days	240 Days	225 Days

Aspirational SMWB Goal

Industry	Aspirational SMWB Goal
Construction	20%

The aspirational SMWB goal is 20% of your total bid price.

Accepted SMWB Certification Agency

- **South Central Texas Regional Certification Agency**

(Includes the Texas Historically Underutilized Business “HUB” Program, MBE, WBE, SBE)

Minimum Qualifications for SMWB recognition:

- SBE-Certified (even MBEs and WBEs)
- ***Local office or local equipment yard***

Good Faith Effort Plan (GFEP) FAQs

- **Q: Is the 20% SMWB goal mandatory?**
A: No, but we ask prime contractors to do their best with good faith outreach efforts. If the goal is not met, proof of outreach efforts is required with the submittal.
- **Q: What if I am having trouble finding SMWB subcontractors?**
A: Please email the SMWB Program Manager with the scopes of work you are seeking. You will receive lists of local SMWB-certified firms to contact.
- **Q: What if my business is SMWB-certified? Do I need to find SMWB subs?**
A: If your firm is SMWB-certified, you will most likely meet the goal. However, the GFEP is a required document, and a good faith outreach effort is still necessary.
- **Q: Do I need to include all my subcontractors in the GFEP or just those that qualify towards the SMWB goal?**
A: All subcontractors need to be included in the GFEP, even those that may not count towards the SMWB goal.
- **Q: What if I have questions about the GFEP?**
A: Please contact the SMWB Program Manager at 210-233-3420, or at Marisol.Robles@saws.org. GFEP questions can be asked at any time before the submittal is due.

Post Award: Subcontractor Payment & Utilization Reporting (S.P.U.R.) System

1. Subcontractor & Supplier Payment Tracking
2. Subcontractor and Supplier Additions or Substitutions
3. LCP Tracker
4. Must be Current and Accurate before Retainage is released

<https://saws.smwbe.com>

The screenshot shows the homepage of the San Antonio Water System's Subcontractor Payment & Utilization Reporting System. The page features a blue header with the San Antonio Water System logo on the left, "OUR MAIN SITE" in the center, and a "CONTACT SUPPORT" button on the right. The main content area has a background image of industrial water treatment equipment. The title "Subcontractor Payment & Utilization Reporting System" is prominently displayed in white text, with a "Log In" button below it. Below the title, there are three columns of links: "System Training" (with a sub-link "Training"), "About the System" (with a sub-link "Information for Vendors"), and "Account Access" (with sub-links "Account Lookup" and "Forgot Password"). At the bottom, a footer states: "The Subcontractor Payment & Utilization Reporting System is powered by B2Cover Software © Copyright 2018."

Contract Solicitations Website – Recent Changes

- To locate the Contract Solicitations website choose Resources

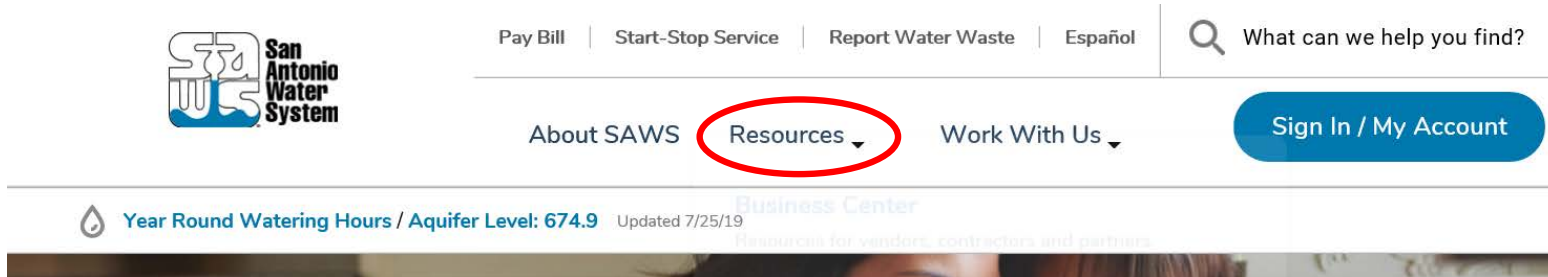

- At the drop down menu choose Contract Solicitations

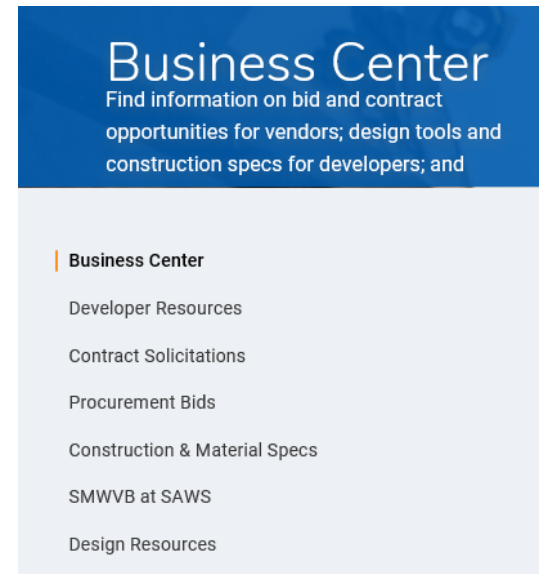

Contract Solicitations Website – Recent Changes

- Choose the specific project
- The following buttons are now located under the advertisement:
 - Notify Me
 - Plan Holder's List
 - Downloads
 - Plans
 - Specs
 - Addendums
 - Geotechnical Data Report



The screenshot displays a project advertisement for a "Non-Mandatory Pre-Bid Meeting" on August 6, 2019. The advertisement includes the following information:

- Calendar Icon:** 31
- Title:** Non-Mandatory Pre-Bid Meeting
- Date:** 10:00 AM, Tuesday Aug. 6, 2019
- Address:** San Antonio Water System Customer Service Building, 2800 U.S. Hwy 281 N, San Antonio, Texas 78212; Conference Room CR-C145

Below the advertisement, there are three main sections:

- Notify Me:** Includes a megaphone icon and a "Subscribe" button. Text: "Receive updates sent straight to your inbox."
- Plan Holders List:** Includes an icon of three people and a "View List" button. Text: "View plan holders list."
- Downloads:** Lists two PDF documents:
 - Specifications:** Jul. 31, 2019. Note: You must be logged in to access this document.
 - Plans:** Jul. 31, 2019. Note: You must be logged in to access this document.

Vendor Registration & Notification (VRN)

- Please register through SAWS Vendor Registration Program on the SAWS website at www.saws.org to ensure access to the latest information.
- To receive updates on specific projects, registered vendors must 'Subscribe' to the project by selecting the project, and clicking 'Subscribe' under the Notify Me box.

https://apps.saws.org/Business_Center/Contractsol/



Notify Me

Receive updates sent straight to your inbox.



Subscribe

Key Reminders

- All questions should be sent in writing to the corresponding Contract Administrator by email or fax.
- Please identify the project by its associated solicitation number.
- Contractors should not contact the SAWS project engineer, the consultants for this project, or any other SAWS staff up until Board award.
- Late bids will not be accepted, and will be returned unopened.
- Due to the COVID-19 emergency and to protect the health of the public, SAWS is implementing new procedures for the submission of bids.
- Bids will be received either Electronically or through Sealed bids.
- Electronic bids will be received via the secure SAWS FTP site.
- Sealed bids will be received by Contract Administration, 2800 U.S. Hwy 281 North, Tower II, Customer Center Building, via a dropbox located on the left wall when walking through the first set of double glass doors of the main Tower II entry on the north side of the building.
- If bids will be delivered in person to SAWS, Bidders should allow sufficient travel time.

IFB Schedule

Questions Due

Friday, August 21,
2020 10:00am (CT)

Bids Due

Monday, August 31,
2020

SMP I – 9:00am (CT)
SMP II – 11:00 am (CT)
SMP III – 1:00 pm (CT)

Board Award

October 6, 2020

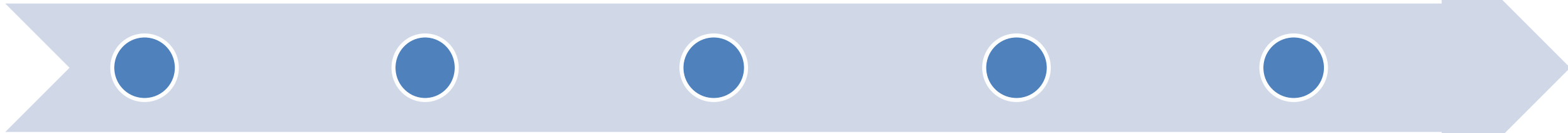

Answers Posted

Tuesday, August 25,
2020 3:00pm (CT)

Bids Due

Tuesday, September 1,
2020

SMP IV – 11:00am (CT)
SMP V – 1:00 pm (CT)
SMP VI – 3:00 pm (CT)

2021 SMP I, II, III, IV, V, VI



Bid Packet Preparation

- Utilize the Bid Packet Checklist within the specifications
 - All items due with the bid
- Double check all mathematical calculations and verify all extensions
- Addendums are acknowledged on the Bid Proposals
- Ensure Mobilization & Prep ROW Line Item does not exceed the percentage allowed
- References and contact information must be verified prior to submitting bid(s)
- A Baseline Schedule should be part of the Bid Packet with an assumed NTP date of November 2, 2020.

Contract Requirements

Prevailing Wage Rate and Labor Standards – Section 2.10 of the General Conditions

- Certified payroll to be submitted on weekly basis
- Wage decisions are included within the specifications
- Contractors to utilize LCP Tracker
- Site visits are random and unannounced
- Interviews will be Conducted and will be private & confidential
- Payroll records are subject to review
- All apprenticeship programs will need to be approved by Department of Labor prior to starting
- Contractors are responsible for sub-contractor payroll
- Late payrolls delay contractor payments from SAWWS

Contract Requirements

- Insurance requirements are found in Section 5.7 of the GCs
 - Pollution Liability & Installation Floater is required
 - Maintain insurance coverage during the construction of this Project
- Compliant prior to executing the contract
- Will ask for insurance prior to Board award to expedite execution of the contract
 - Any deficiencies must be corrected prior to Board award

Contact Information

Contact Name	Title	Telephone Number	Email address
Florinda Gonzales	Interim Contract Administrator	210-233-3914	Florinda.Gonzales@saws.org
Stella Manzello	Contract Administrator	210-233-3854	Stella.Manzello@saws.org
Marisol V. Robles	SMWB Program Manager	210-233-3420	Marisol.Robles@saws.org

Project Overview

- Bids for construction are for specified contracts with mostly open cut replacement:

Contract	Water Scope	Sewer Scope
Package I	4,450 LF of 6 to 8-in	144 LF of 8-in
Package II	2,888 LF of 8 to 12-in	1,172 LF of 8-in
Package III	3,771 LF of 6 to 12-in	2,352 LF of 8 to 10-in
Package IV	4,698 LF of 6 to 8-in	933 LF of 8 to 10-in
Package V	2,531 LF of 6, 8, & 12-in	1,657 LF of 8-in (*OC) & 1,092 LF of 8-in (*PB)
Package VI	3,124 LF of 6 to 8-in	1,791 LF of 8-in

*OC – Open Cut

*PB – Pipe Bursting

- Projects are part of 2021 CoSA's Street Maintenance Program (SMP)
- Contractor is to become familiar with the plans, specifications and the project site.

Project Overview

Statement of Bidder's Experience

- Traffic Control Plans, Bypass Pumping Plan will be responsibility of contractor and at no cost to SAWS
- Contractor's Bid Packet Checklist
- Detailed Construction schedule must be part of the bid
- Submittals can be turned in as soon as receiving notification of contract award after CPMS training (if necessary) has been completed
- Mobilization and Prep ROW are separate pay items per package
 - Not to exceed 15% combined
- Prep ROW includes clearing and grubbing, tree pruning, tree protection.
- Traffic Handling and Barricades will be paid per site

Project Overview

Special Conditions

- Final completion of all projects shall be achieved in the specified calendar days of each contract.
- Contractor will perform work within permanent and temporary easements.
- All work on these packages is anticipated in CoSA ROW.
- Contractor should schedule work accordingly to complete the project within the specified days.
- Contractor must obtain CoSA ROW permit to start work.
 - <http://rowpermits.sanantonio.gov/>

Project Overview

Supplemental Conditions

- Contractor shall perform the work with its own organization on at least 40% of the total original contract price.
- Liquidated damages will be assessed as follows for final completion extending beyond contract time:

Liquidated Damages Charges		
Category	Duration (days)	Charge (\$) per day
Tier 1	1-7	\$460.00
Tier 2	8-14	\$540.00
Tier 3	15-21	\$600.00
Tier 4	22-28	\$640.00
Tier 5	29-35	\$670.00
Tier 6	36-42	\$690.00

- Any days tallied after 42 days will be assessed as a Tier 6 rate.
- Contractors will submit a baseline schedule with bids.



2021 SMP Package I (Buckwheat, Sunny Glen, Mider)

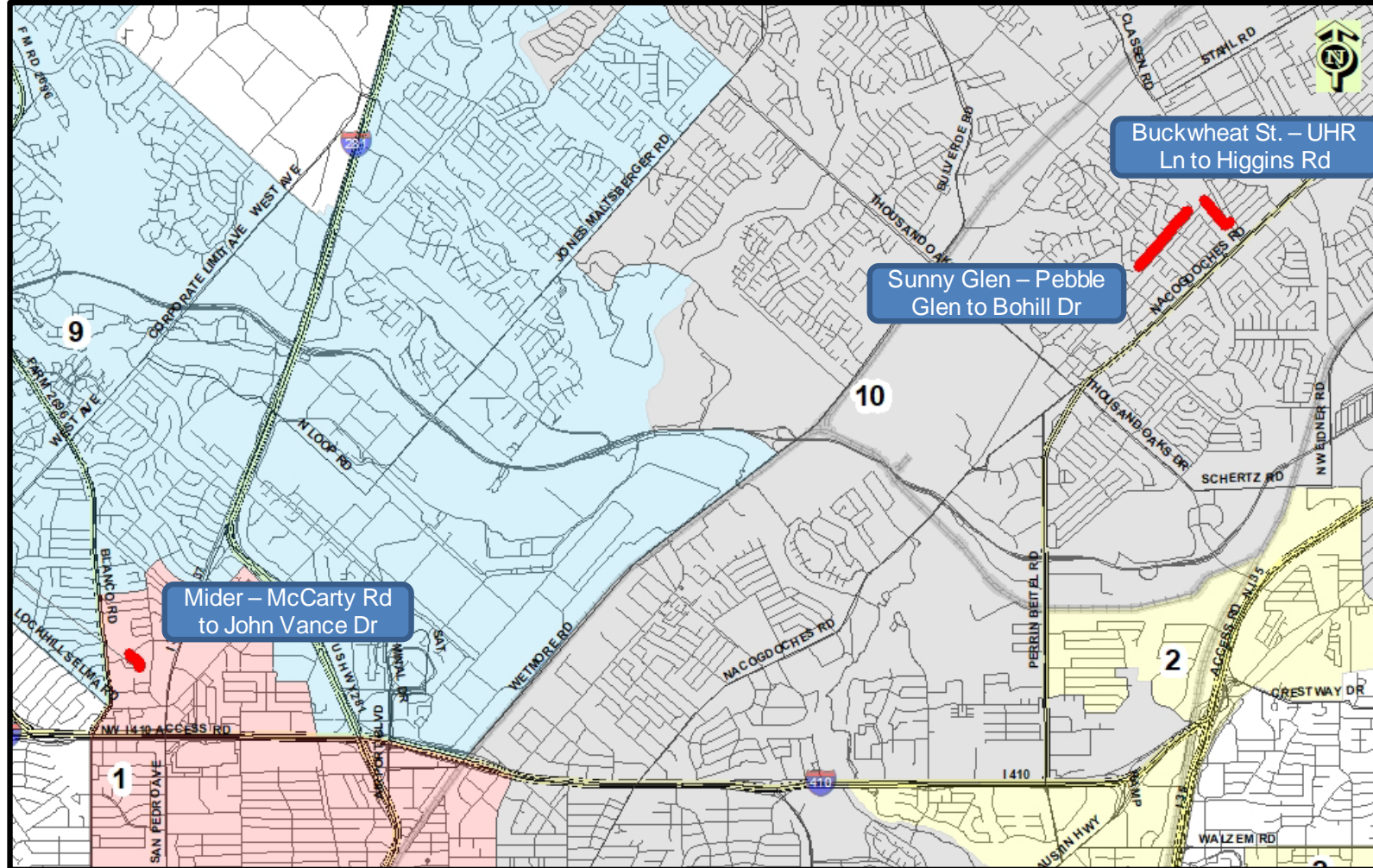

Project Details (2021 SMP Package I)

In anticipation of the City of San Antonio's Street Maintenance Program (SMP) project SAWS wishes to replace existing utility infrastructure as follows:

- **Buckwheat St.** from Uhr Ln. to Higgins Rd.: Replace existing 6" AC water main with approximately 1303 LF of new 6", 8", & 16" PVC water main including relaying water services.
- **Sunny Glen** from Pebble Glen to Bohill Dr.: Replace existing 6" AC water main with approximately 2567 LF of new 6" & 8" PVC water main including relaying water services.
- **Mider Dr.** from McCarty Rd. to John Vance Dr.: Replace existing 6" AC water main with approximately 580 LF of new 8" PVC water main including relaying water service. Replace existing 8" sanitary sewer main with approximately 144 LF of new 8" PVC sanitary sewer main including replacing sanitary sewer laterals and manholes.
- Common Items to Note Across All Locations:
 - Concrete encasement and flowable fill required at multiple locations
 - Utility crossings
 - Some sidewalk and driveway reconstruction anticipated
 - Removal of AC water main at tie-ins
 - Tree protection required

Project Details (2021 SMP Package I) – Buckwheat Street



Buckwheat Street (Uhr Lane to Higgins Road)

- Water tie-in on Higgins Road will require moving traffic over to north side of road, one lane in each direction.
- 2” mill and overlay at tie-in locations on Uhr Lane and Higgins Road along with matching pavement markings.



Intersection of Buckwheat and Higgins

Project Details (2021 SMP Package I) – Sunny Glen



Sunny Glen (Pebble Glen to Bohill)

- Underground AT&T line located at tie-ins at Sunny Walk
- Numerous utility crossings throughout project length
- Trees overhang roadway and may requiring trimming (NSPI)



Sunny Glen Looking North

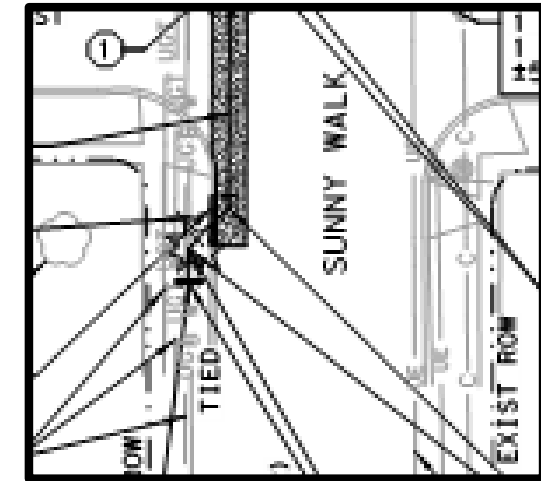

Sunny Glen at Sunny Walk

Project Details (2021 SMP Package I) – Mider Drive

- Proposed water main will cross under sanitary sewer in two locations requiring steel casing.
- Sewer manhole within McCarty Road to be replaced.
- Sewer main dead-ends along Mider Drive.



Mider Drive (McCarty Road to John Vance Drive)

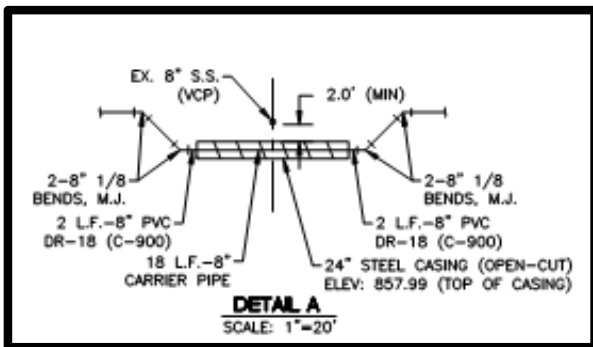
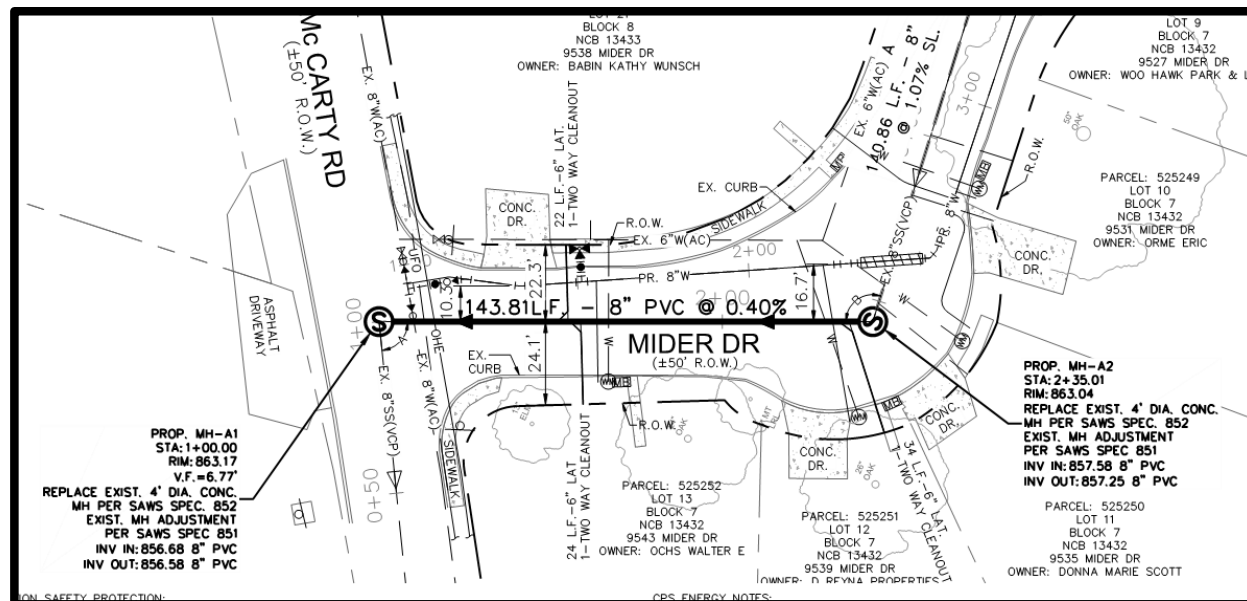



2021 SMP Package II (Guadalajara, Minuteman, Village Haven)

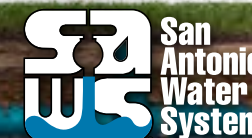
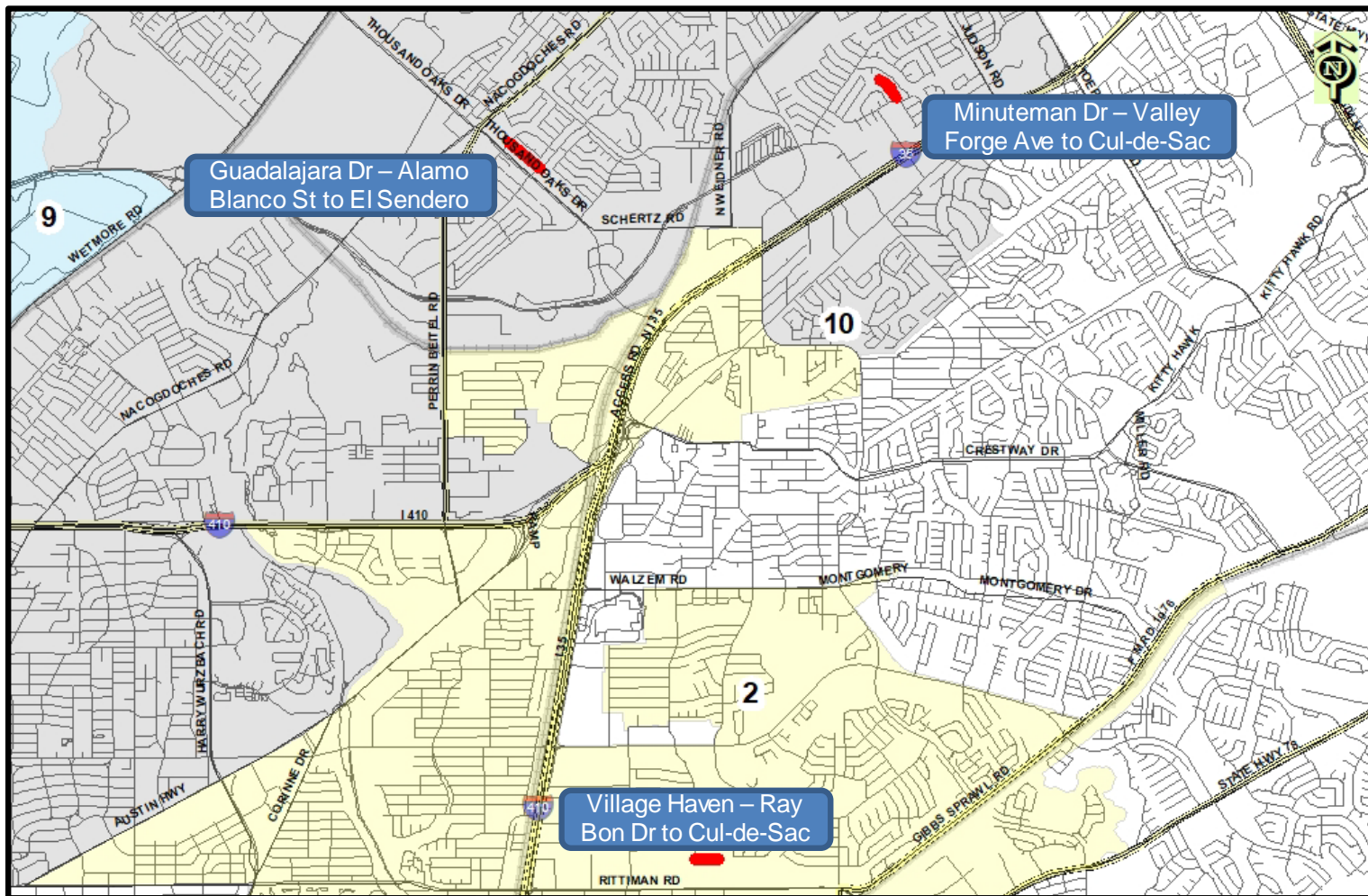

Project Details (2021 SMP Package II)

In anticipation of the City of San Antonio's Street Maintenance Program (SMP) project SAWS wishes to replace existing utility infrastructure as follows:

- **Guadalajara Dr.** from Alamo Blanco St. to El Sendero St.: Replace existing 6" AC water main with approximately 1323 LF of new 6" & 8" PVC water main including relaying water service. Replace existing 8" sanitary sewer main with approximately 1172 LF of new 8" PVC sanitary sewer main including replacing sanitary sewer laterals and manholes
- **Minuteman Dr.** from Cul-de-Sac. to Valley Forge Ave.: Replace existing 6" AC water main with approximately 755 LF of new 8" PVC water main including relaying water service.
- **Village Haven** from Ray Bon Dr. to the end of Village Haven: Replace existing 6" AC water main with approximately 810 LF of new 8" & 12" PVC water main including relaying water service.
 - This site must be prioritized first
- Common Items to Note Across All Locations:
 - Flowable fill and/or concrete encasement required at multiple locations
 - Utility crossings
 - Some sidewalk and driveway reconstruction anticipated
 - Removal of AC water main at tie-ins
 - Tree protection required

Project Details (2021 SMP Package II) – Guadalajara Drive

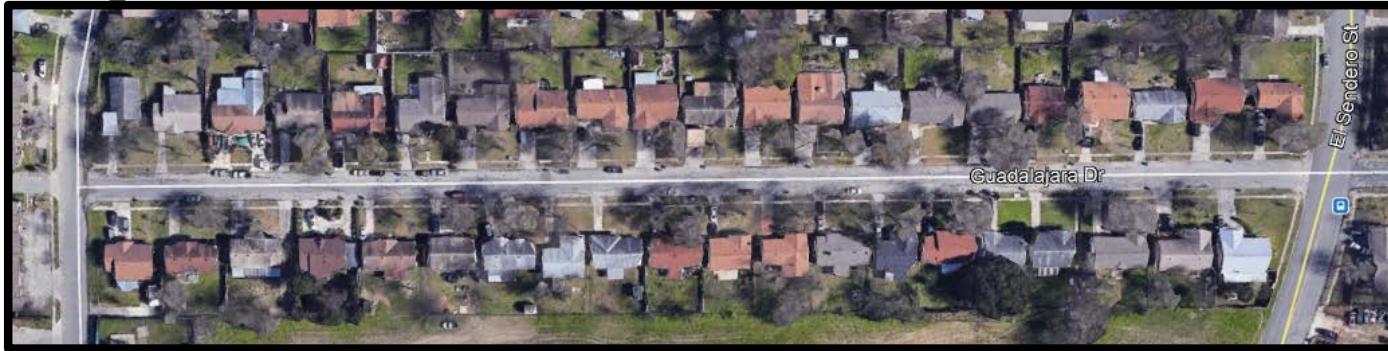

Guadalajara Drive (Alamo Blanco Street to El Sendero Street)

- 2” mill and overlay at tie-in location on Alamo Blanco Street along with driveway replacement
- Bypass pumping required along Guadalajara and Alamo Blanco
- Sewer ranges in depth from approximately 6’ to 16’.

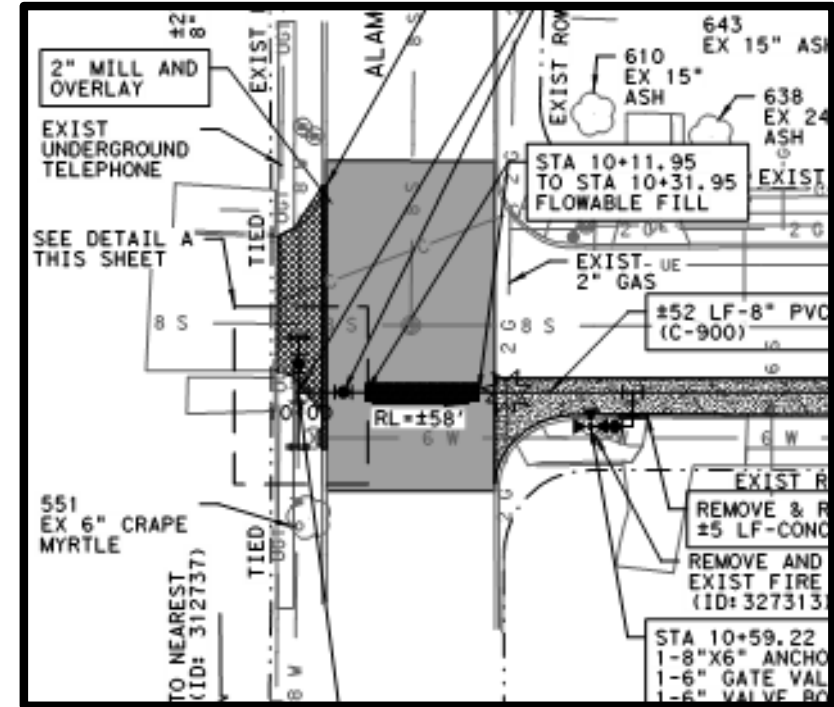

Intersection of Guadalajara and Alamo Blanco

Project Details (2021 SMP Package II) – Minuteman Drive



Minuteman Drive (Valley Forge Avenue to Cul-de-Sac)

- Concrete encasement required for segments near existing sewer
- No sewer work
- Coordinate with residents to maintain access



Cul-de-sac on Minuteman Drive



Minuteman at Valley Forge

Project Details (Package II Water) – Village Haven



Village Haven (Ray Bon Drive to Cul-de-Sac)

- 2" mill and overlay and driveway replacement at tie-in on Ray Bon Drive
- Only other utility in street appears to be a Google Fiber cable buried within a foot of the curb on both sides with a crossing at Ray Bon Drive
- No sewer work
- Ray Bon Drive dead-ends at Village Haven
- Coordinate with residents to maintain access
- **This site must be prioritized first**

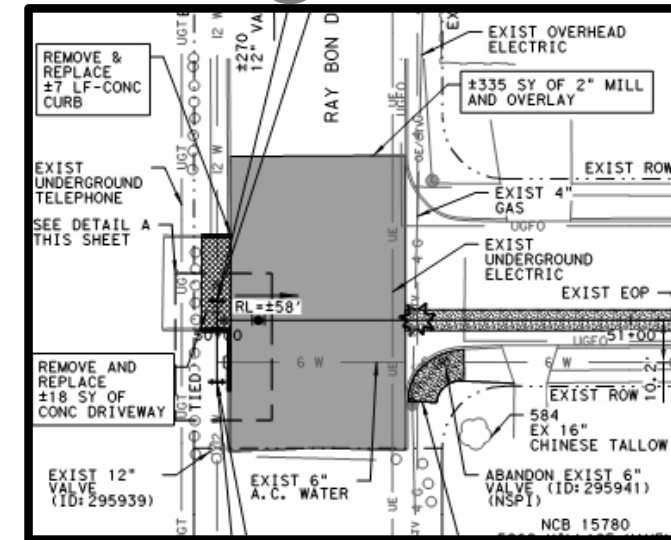

Village Haven at Ray Bon Drive





2021 SMP Package III

(Gorman St, Wyoming St, Paul St, NW 20th St)

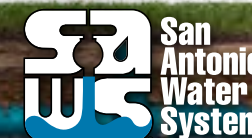
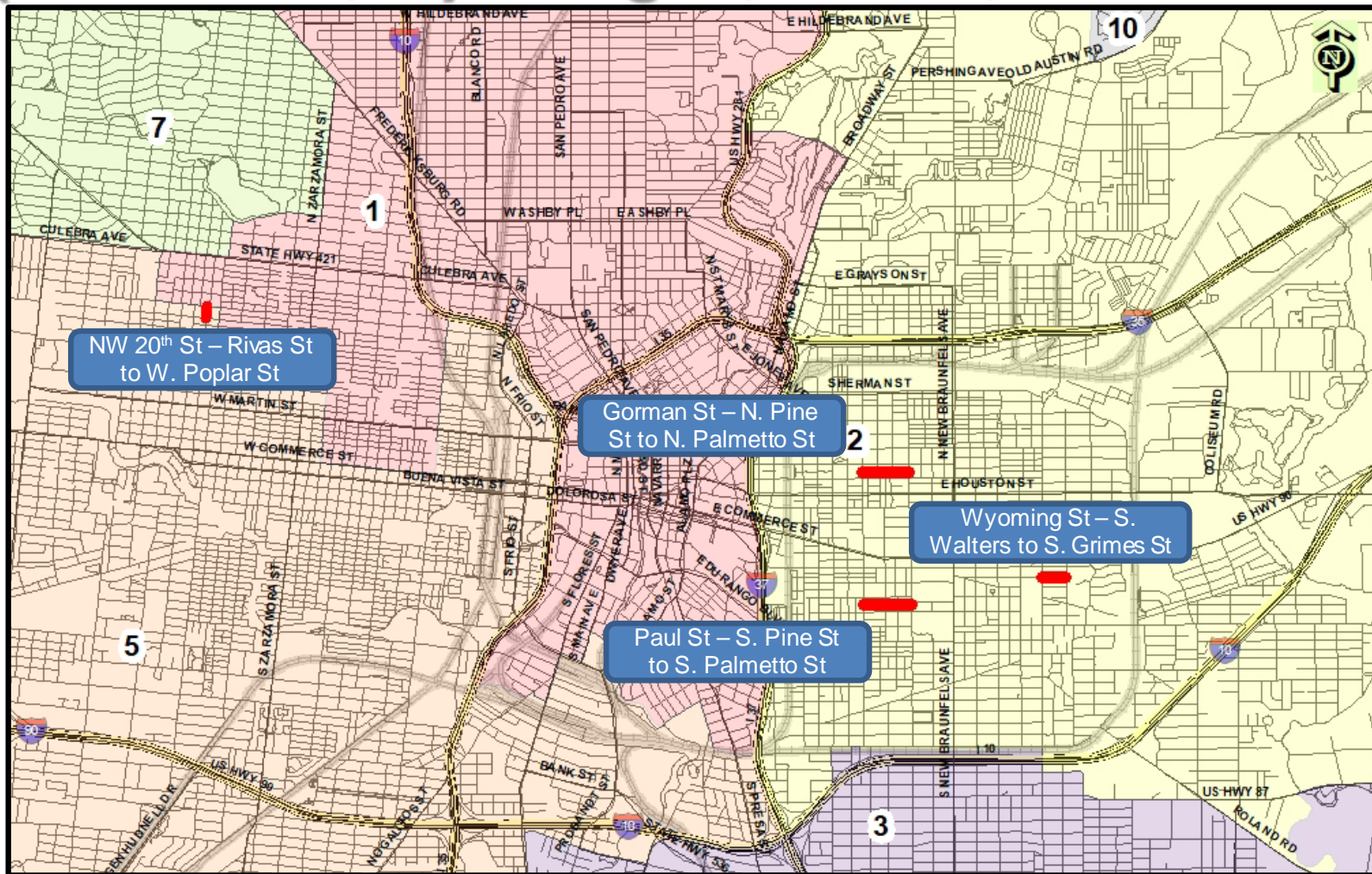

Project Details (Package III)

- Package III Scope

- Four sites: Gorman St., Paul St., Wyoming St., & NW 20th St
- Water – 3,771 LF of 6- to 12-inch PVC
- Sewer – 2,352 LF of 8- and 10-inch PVC

- Site Specific Scope

Gorman St (N Pine St to N Palmetto St)

- Water – 1,632 LF of 8-inch PVC (some 6-inch PVC at tie-ins)
- Sewer – 1,005 LF of 8-inch PVC

Paul St (S Pine St to S Palmetto St)

- Water – 1,599 LF of 8-inch PVC (some 6-inch PVC at tie-ins)
- Sewer – 1,007 LF of 8-inch PVC, plus lateral replacements on a previously rehabilitated main

Project Details (Package III)

Wyoming St (S Walters St to S Grimes St)

- Water – no work in scope
- Sewer – 340 LF of 10-inch PVC, plus lateral replacements on a previously rehabilitated main

NW 20th St (Rivas St to W Poplar St)

- Water – 540 LF of 8- and 12-inch PVC (some 6-inch PVC at tie-ins)
- Sewer – no work in scope

Project Details (Package III)

- Gorman St:

- Narrow road, several utilities within it
 - Overhead Electric, and underground Gas and Fiber Optic cable along project limits
- Sewer main to be removed and replaced in place
- Water mains to be encased in areas near proposed sewer mains and manholes (refer to plans)
- Removal of AC pipe at Tie-ins
- Pavement Restoration To Be Performed to Limits Shown in the Plans
 - Trench to be restored with 10" Type B HMAC and 2" Type D HMAC
- CoSA Tree Permit
 - Applies to tree trimming where branches overhang onto street and root protection



Gorman St (N Pine St to N Palmetto St)

Project Details (Package III)

- Gorman St:
 - Water alignment is in close proximity to existing sewer and gas. Field Investigation ahead of work are very important.

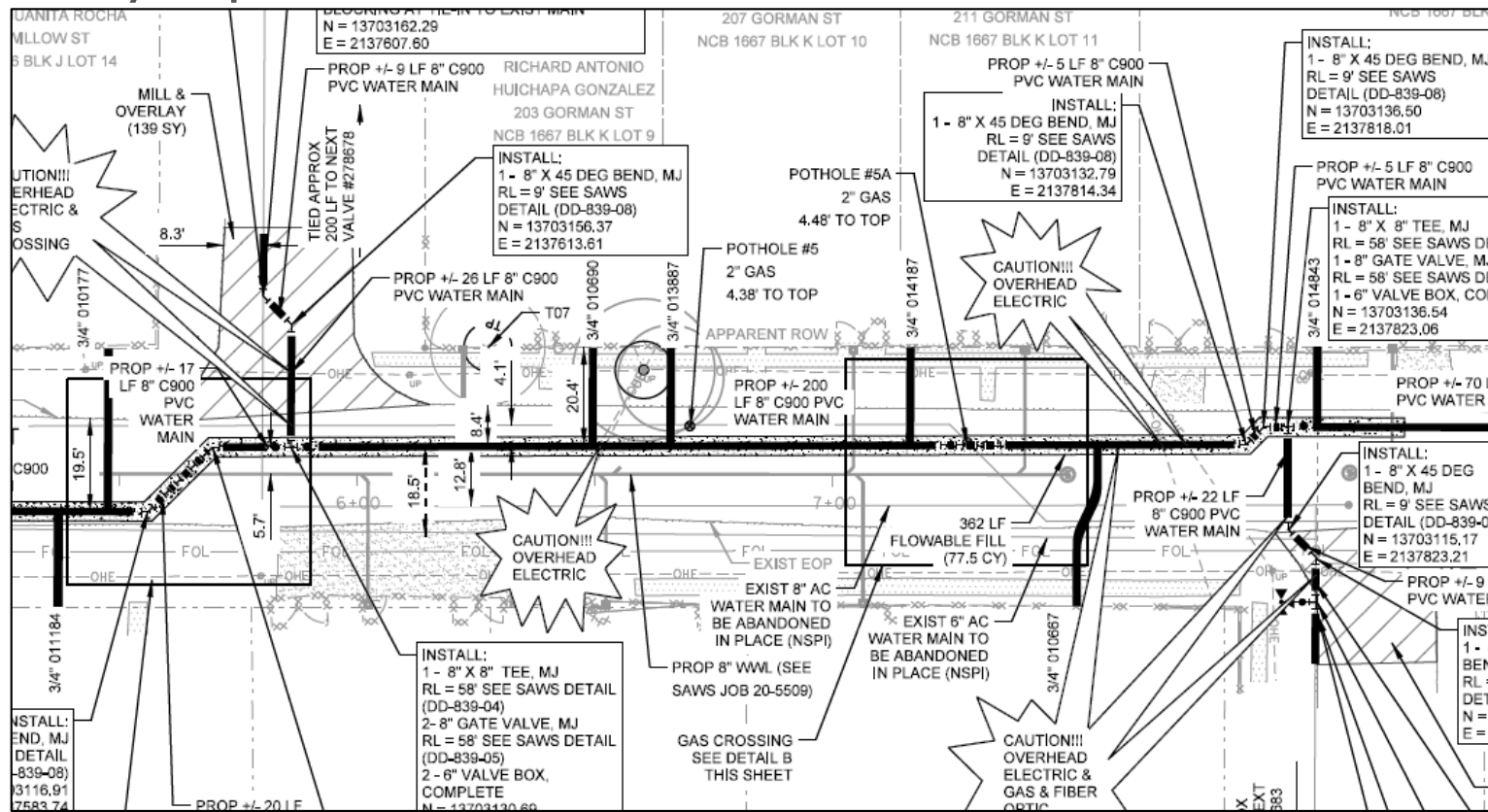

Project Details (Package III)

- Paul St:

- Narrow road, several utilities within it
 - Overhead Electric, and underground Gas and Fiber Optic cable along project limits
 - Existing 54-inch storm sewer main within Piedmont Avenue
- Sewer main to be removed and replaced in place
 - 400 LF of the existing main was previously rehabilitated and only the laterals are being replaced with this project
- Water mains to be encased in areas near proposed sewer mains and manholes (refer to plans)
- Removal of AC pipe at Tie-ins
- Pavement Restoration To Be Performed to Limits Shown in the Plans
 - Trench to be restored with 10" Type B HMA and 2" Type D HMA
- CoSA Tree Permit
 - Applies to tree trimming where branches overhang onto street and root protection



Paul St (S Pine St to S Palmetto St)

Project Details (Package III)

- Paul St:
 - Existing concrete retaining walls on the north side of the roadway at the ROW line
 - Plans call for removal and replacement to install services
 - Some properties include a decorative wall on private property that must be protected during construction, or replaced at no cost to SAWS

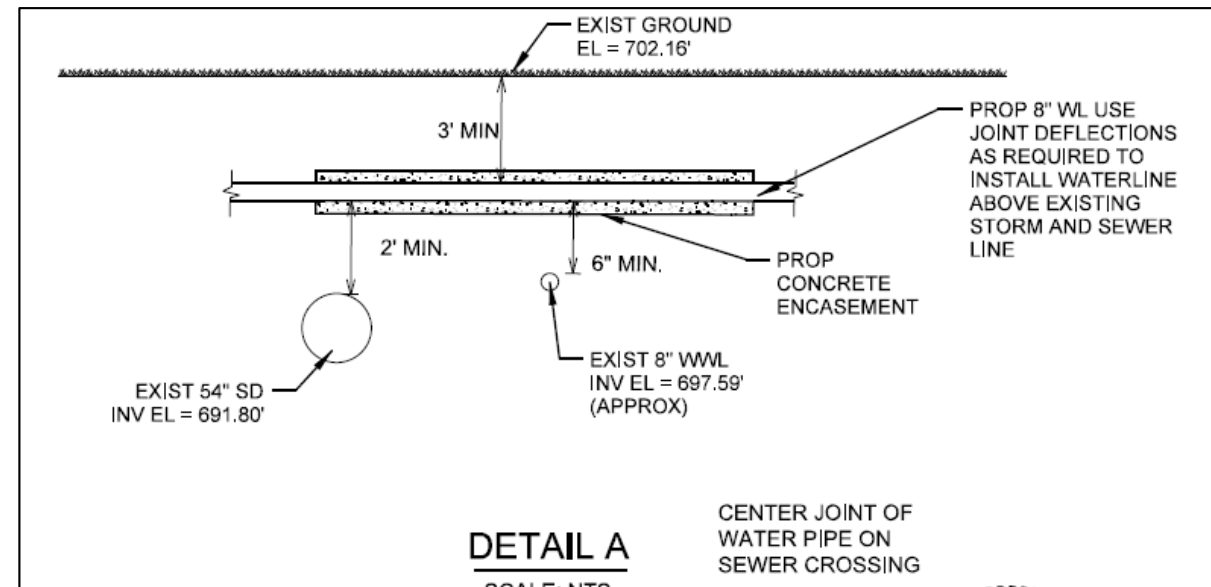

Project Details (Package III)

- Wyoming St:
 - Narrow road, several utilities within it
 - Overhead Electric, and underground Gas and Fiber Optic cable along project limits
 - Two sewer mains in the project limits:
 - One sewer main to be removed and replaced in place
 - Other sewer main was previously rehabilitated and only the laterals are being replaced with this project
 - No water in the scope
 - Pavement Restoration To Be Performed to Limits Shown in the Plans
 - Trench to be restored with 10" Type B HMAC and 2" Type D HMAC
 - CoSA Tree Permit
 - Applies to tree trimming where branches overhang onto street and root protection



Wyoming St (S Walters St to S Grimes St)

Project Details (Package III)

- NW 20th St:
 - Narrow road, several utilities within it
 - Overhead Electric, and underground Gas and Fiber Optic cable at intersections
 - Water mains to be encased in areas near existing sewer mains and manholes (refer to plans)
 - Removal of AC pipe at Tie-ins
 - No sewer in the scope
 - Pavement Restoration To Be Performed to Limits Shown in the Plans
 - Trench to be restored with 10" Type B HMAC and 2" Type D HMAC
 - CoSA Tree Permit
 - Applies to tree trimming where branches overhang onto street and root protection

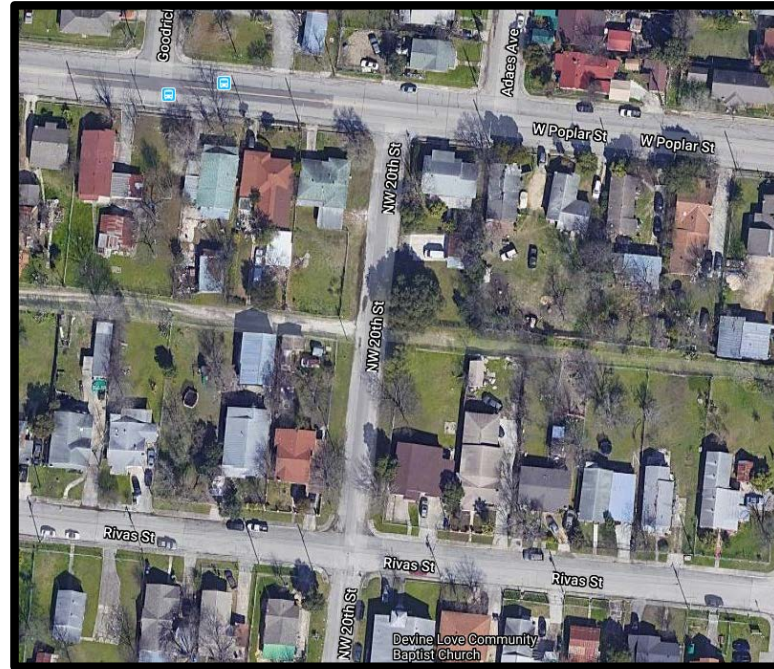

NW 20th St (Rivas St to W Poplar St)



2021 SMP Package IV (Neff Ave., Rena Dr., Rouse, Topaz St.)

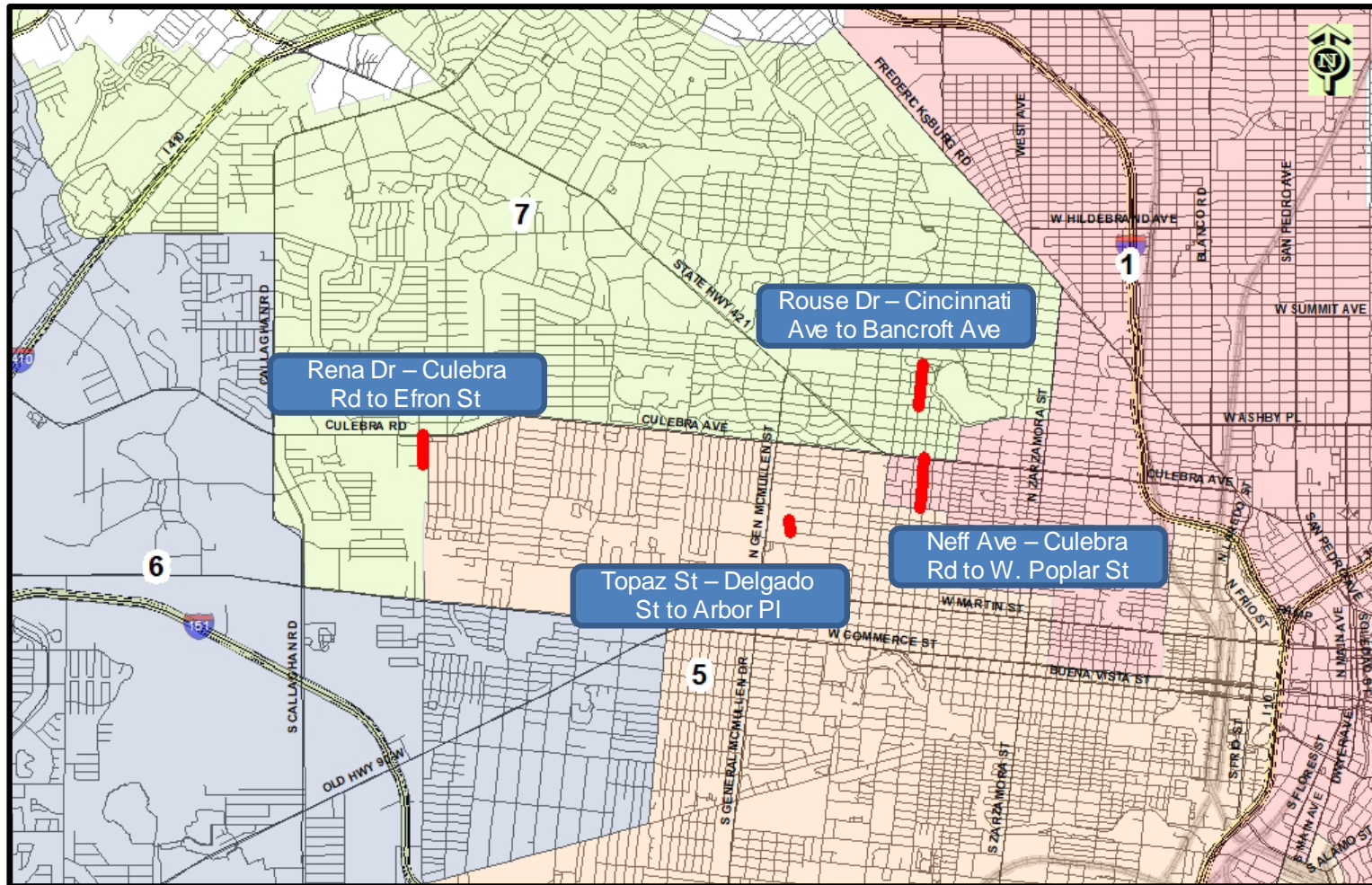

Project Details (Package IV)

- Package IV Scope

- Four sites: Neff Ave, Rena Dr, Rouse Dr, & Topaz St
- Water – 4,698 LF of 6- and 8-inch PVC
- Sewer – 933 LF of 8- and 10-inch PVC

- Site Specific Scope

Neff Ave (Culebra Rd to W Poplar St)

- Water – 1,707 LF of 8-inch PVC (some 6-inch PVC at tie-ins)
- Sewer – no work in scope

Rena Dr (Culebra Rd to Efron St)

- Water – 1,087 LF of 8-inch PVC (some 6-inch PVC at tie-ins)
- Sewer – 535 LF of 8-inch PVC

Project Details (Package IV)

Rouse Dr (Cincinnati Ave to Bancroft Ave)

- Water – 1,479 LF of 8-inch PVC (some 6-inch PVC at tie-ins)
- Sewer – 398 LF of 10-inch PVC

Topaz St (Delgado St to Arbor Pl)

- Water – 425 LF of 8-inch PVC (some 6-inch PVC at tie-ins)
- Sewer – no work in scope

Project Details (Package IV)

- Neff Ave:

- Existing Utilities
 - Overhead electric
 - Water main
 - Sewer crossing
 - Gas crossings
 - Telecom crossing
- No sewer work
- Pavement Restoration To Be Performed to Limits Shown in the Plans
 - Trench to be restored with 10" Type B HMAC and 2" Type D HMAC
 - 2" mill and overlay at Lombrano and W Poplar intersections
- CoSA Tree Permit
 - Applies to tree trimming where branches overhang onto street and root protection

Neff Ave (Culebra Rd to W Poplar St)



Project Details (Package IV)

- Rena Dr:

- Existing Utilities
 - Overhead electric
 - Water main
 - Sewer main
 - Gas main
- Removal of AC pipe at Tie-ins
- Sewer main to be removed and replaced in place
- Pavement Restoration To Be Performed to Limits Shown in the Plans
 - Trench to be restored with 10" Type B HMAC and 2" Type D HMAC
 - Trench outside of pavement to be restored to existing conditions (NPSI)
- CoSA Tree Permit
 - Applies to tree trimming where branches overhang onto street and root protection

Rena Dr (Culebra Rd to Efron St)



Project Details (Package IV)

- Rouse Dr:

- Existing Utilities
 - Overhead electric
 - Water main
 - Sewer main
 - Gas main
 - Telecom
- Sewer main to be removed and replaced in place
- Removal of AC pipe at Tie-ins
- Pavement Restoration To Be Performed to Limits Shown in the Plans
 - Trench to be restored with 10” Type B HMAC and 2” Type D HMAC
 - 2” mill and overlay at W French intersection
- CoSA Tree Permit
 - Applies to tree trimming where branches overhang onto street and root protection

Rouse Dr (Cincinnati Ave to Bancroft Ave)



Project Details (Package IV)

- Topaz St:
 - Existing Utilities
 - Overhead electric
 - Water main
 - Sewer main
 - Gas main
 - Pavement Restoration To Be Performed to Limits Shown in the Plans
 - Trench to be restored with 10" Type B HMAC and 2" Type D HMAC
 - CoSA Tree Permit
 - Applies to tree trimming where branches overhang onto street and root protection

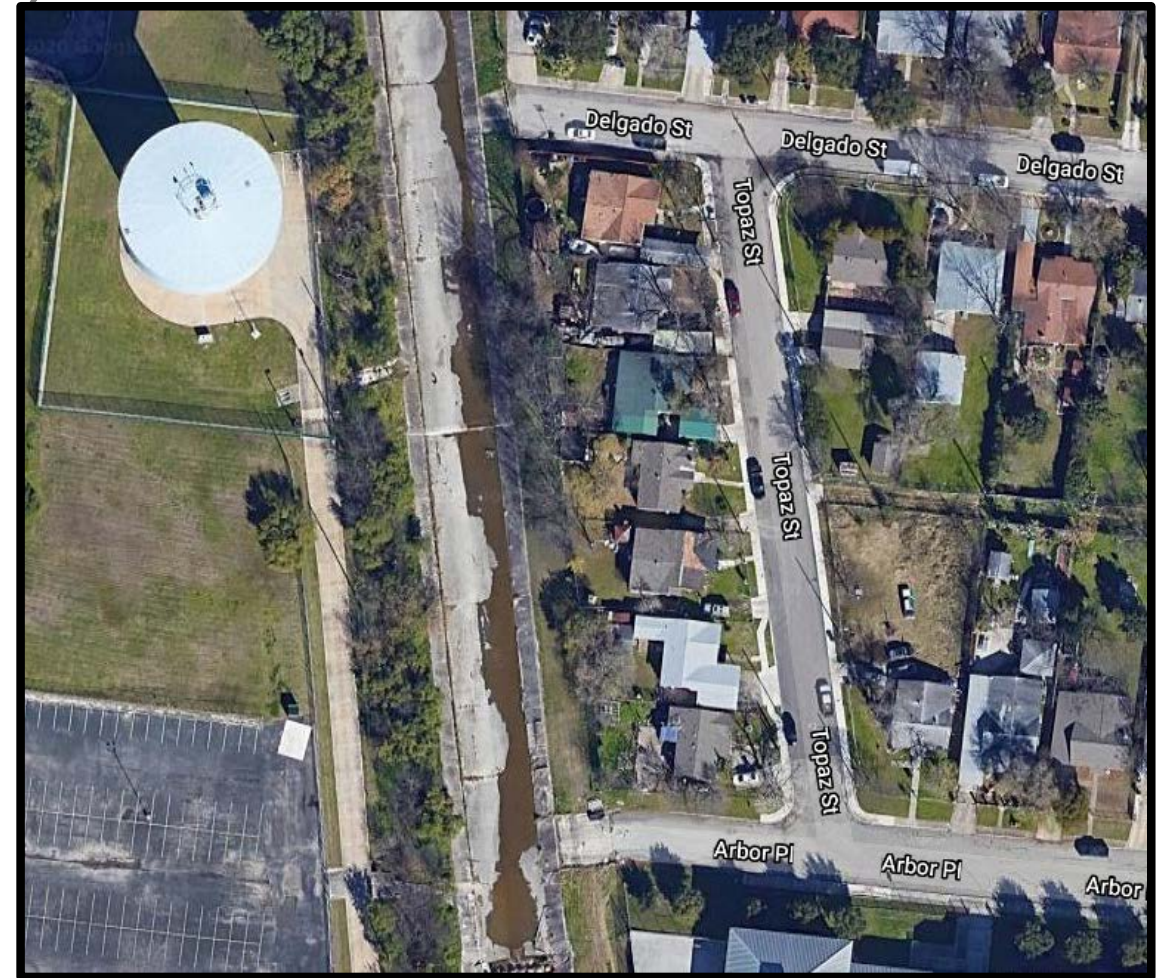

Topaz St (Delgado St to Arbor Pl)



2021 SMP Package V (Hilary Rd, Delaware, Whitefield)

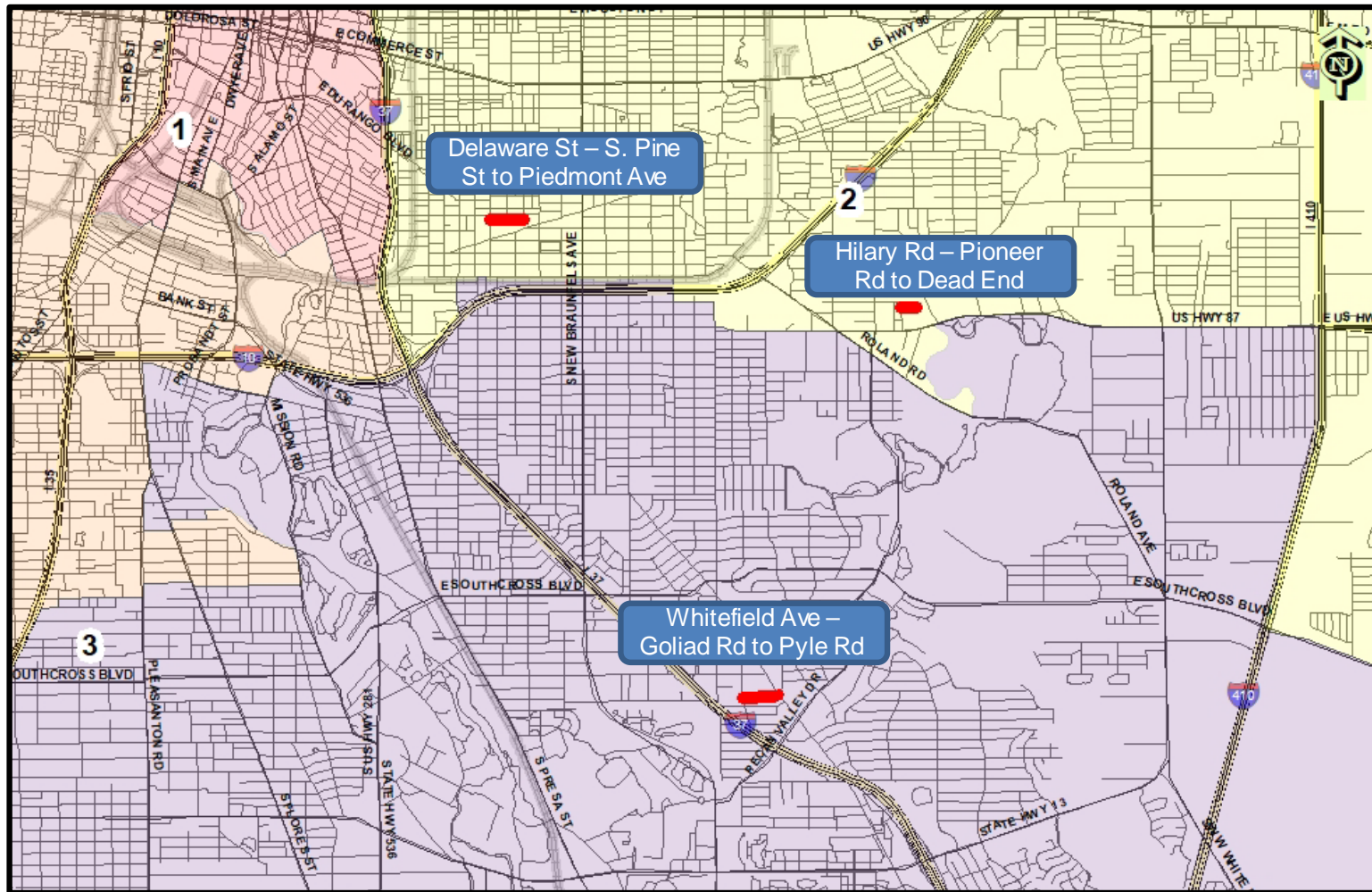

Project Details (2021 SMP Package V)

- Package V Scope

- Three sites: Hilary Rd (Sewer Only), Delaware St, & Whitefield Ave – 240 Calendar Days

- Water – 2,531 LF of 8-inch – 12-inch C-900 PVC and Ductile Iron Pipe
- Sewer – 1,657 LF of 8-inch PVC (Replace in Place), 1,092 LF of 8-inch HDPE (Pipe Burst)
- Contractor to submit bypass plan for all 3 sites and traffic control plan (TCP) for approval

- Site Specific Scope Overview

- **Hilary Rd** (Pioneer Rd to Hilary Rd Dead End)

- Water – No proposed work
- Sewer – 476 LF of 8-inch PVC (Replace in Place) and 352 LF of 6-inch sewer laterals w/2-way cleanouts

- **Delaware St** (S Pine St. to Piedmont Ave)

- Water – 1,120 LF of 8-inch PVC (6-inch pvc at tie-ins on Dreiss St)
- Sewer – 1,030 LF of 8-inch PVC (Replace in Place) and 916 LF of 6-inch sewer laterals w/2-way cleanouts

- **Whitefield Ave** (Goliad Rd to Pyle St)

- Water – 1,136 LF of 8-inch DI (6-inch DI and 12-inch DI at tie-ins on Pyle St and Goliad Rd)
- Sewer – 1,092 LF of 8-inch HDPE (Pipe Burst) and 17 EA svc reconnects by open cut excavation w/2-way cleanouts

Project Details (2021 SMP Package V)

• Hilary Rd

- Residential dead-end road, sewer in middle of street (replace in place), 1 recon MH, 1 rem/rep MH, 1 new MH

- Utilities:

- Existing 6" DI water main parallels sewer about 6.5'-7.5' from exist. sewer
- Overhead electric powerlines throughout street
- 2" gas line runs parallel to exist. sewer about 7.5'-8' from sewer (caution when digging for sewer laterals)
- Fiber optic (AT&T) runs parallel to exist. sewer about 19' from sewer (caution when digging for sewer laterals)
- Existing 6" DI water main on Pioneer Rd adjacent to MH 90499 to be reconstructed
- Replacement of driveways where sewer laterals are being replaced to property line

- New manhole at end of line where currently ends in stub-out
 - Contractor to verify angle of invert and horizontal/vertical orientation of main at end of line
- Concrete encasement between last two manholes due to shallow depth



Project Details (2021 SMP Package V)

End of sewer main on Hilary Rd

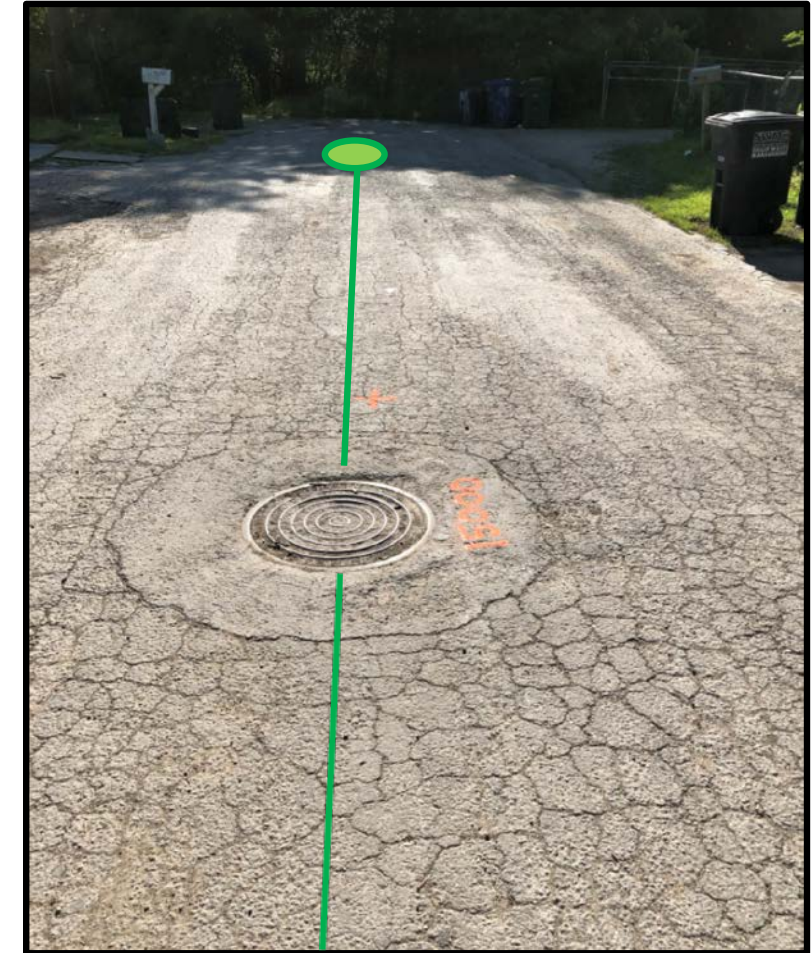
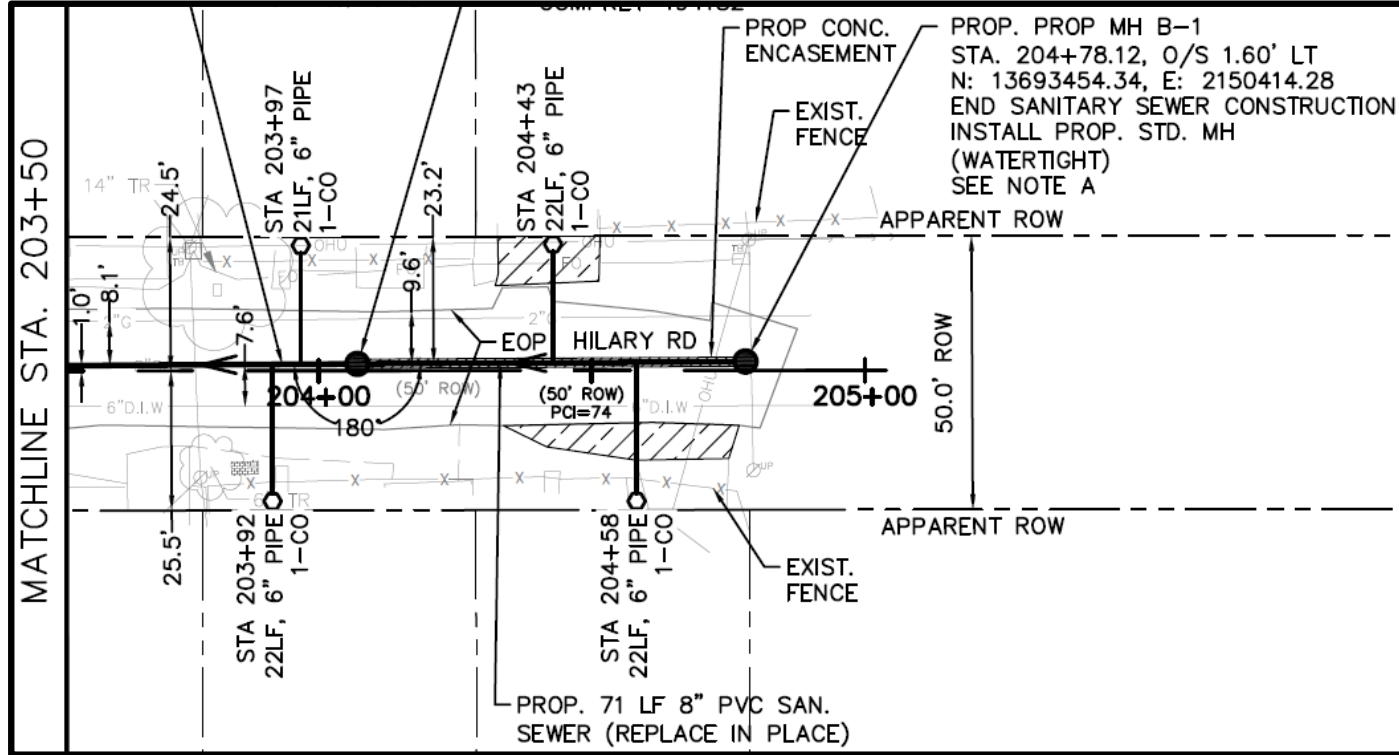

Project Details (2021 SMP Package V)

• Delaware St

- Residential road with sewer in middle of street (replace in place) and exist. water along south ROW and to be replaced along the north ROW (8-inch PVC); 2 rehab MH, 1 rem/rep MH at Dreiss St intersection
 - Utilities:
 - Exist. 6" AC water main parallels sewer about 9.5'-10' from exist. sewer
 - Multiple overhead electric powerlines crossing street with power poles along south ROW close to exist. AC water main
 - 2" gas main along Delaware - about 7.5' from exist. sewer and 3'-6.3' from proposed water (use caution when digging water main trench and sewer laterals and water line relays)
 - 2" gas crossing on S. Pine St, 4" gas crossing on Dreiss St, 4" gas crossing on S. Piedmont St (pothole conducted at Piedmont for water tie-in - data will be shown on addendum) – Prop. water to cross under where necessary to keep 2' min. separation per detail in plans.
- Prop. water will be within 9' (4.7' at the least) from exist. sewer beginning at S. Pine St to Dreiss St – new sewer main to include flowable fill 12" around prop. sewer main and around new manhole at Dreiss St
- AC pipe removal, transport and disposal where called out and as necessary
- Verify water services for each resident – Specific locations called out to verify close to S Pine St/Delaware St
- Mill and Overlay S. Pine St and Delaware intersection due to high PCI (74-76) of S. Pine St – Included in Sewer plans quantities and to be completed following water and sewer improvements



Project Details (2021 SMP Package V)

- S. Pine St and Delaware St intersection – Mill & Overlay

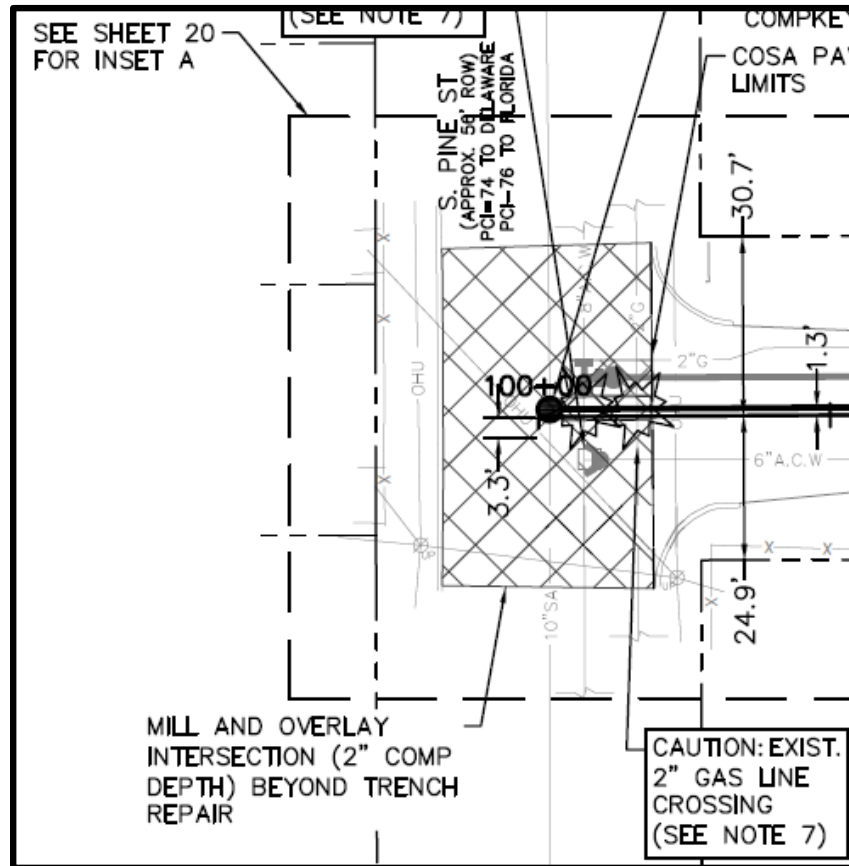

Project Details (2021 SMP Package V)

• Whitefield Ave

- Residential road leading to commercial at Goliad Rd with sewer under sidewalk in south ROW (pipe burst) and exist. water along north ROW to be replaced 4' from face of curb (8-inch DI); 1 rehab MH, 3 rem/rep MH
 - Utilities:
 - Overhead electric utility lines crossing over prop. water and sewer improvements
 - 4" gas main along Pyle Rd crossing prop. Water and Sewer (use caution when digging water main trench and while pipe bursting sewer)
 - Fiberoptic line (Verizon) crossing at Whitefield and Goliad – Prop. water to cross under where necessary to keep 2' min. separation per detail in plans.
- Whitefield Ave includes new sidewalks and driveways – minimize extents of excavation where possible
- Prop. water will be 8" D.I. and will tie-in with exist. 12-inch CI water main at Goliad and exist. 6-inch DI water main at Pyle Rd
- Sewer laterals to be replaced to apparent ROW line & reconnected by open-cut excavation with 2-way cleanout
- 12-inch CI water main tie-in at Goliad Rd **to be conducted at night after business hours.**
- Water tie-in to be coordinated with SAWS Inspection Division and affected business owners prior to shutdown.



Project Details (2021 SMP Package V)

- Whitefield Ave – Sewer under sidewalk; Water to be under street offset 4' from FOC



Project Details (2021 SMP Package V)

- Other Details (Whitefield Continued):
 - All water service lines and sewer laterals are to be installed to the apparent ROW
 - Contractor to hand dig and take extreme caution and care when uncovering existing utilities (caution star shown on plans at utility crossings with proposed mains)
 - Pavement Restoration to be Performed to Limits Shown in the Plans
 - Trench to be restored with 10” Type B HMAC and 2” Type D HMAC per trench detail in water and sewer plans (flowable fill around prop. sewer on Delaware St)
 - CoSA Tree Permit
 - Any trees found on private property with branches that overhang onto public ROW may require trimming, pruning, and root protection for construction where identified (NSPI)



2021 SMP Package VI (Hale, Kernan Dr., Hoover Ave.)

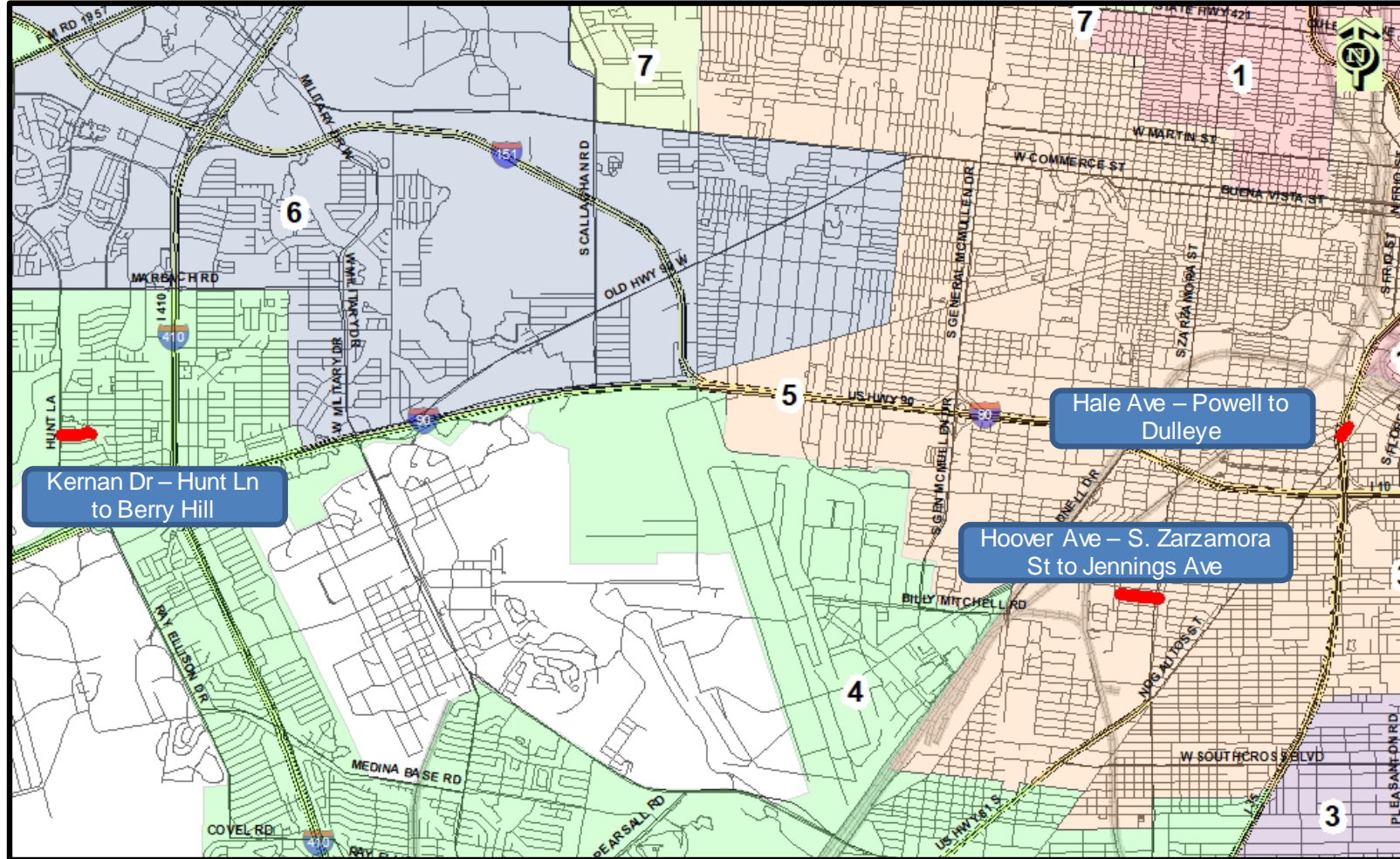

Project Details (Package VI)

- Package VI Scope

- Three sites: Hale Avenue, Hoover Avenue, & Kernan Drive
- Water – 3,080 LF of 8-inch, 44 LF of 6-inch (3,124 LF Total)
- Sewer – 1,725 LF of 8-inch PVC (ASTM D-3034), 66 LF of 8-inch PVC (ASTM D-2241) (1,791 LF Total)
- Note water and sewer summary totals reflect an approximate 10% contingency in the quantity

- Site Specific Scope

Hale Avenue (Dickey Street to Powell Street)

- Water – No water work proposed
- Sewer – 273 LF of 8-inch PVC

Hoover Avenue (South Zarzamora Street to Jennings Avenue)

- Water – 1,495 LF of 8-inch PVC (some 6-inch PVC at tie-ins)
- Sewer – 1,355 LF of 8-inch PVC

Kernan Drive (Hunt Lane to Berry Hill)

- Water – 1,305 LF of 8-inch PVC (some 6-inch PVC at tie-ins)
- No sewer work proposed

Project Details (Package VI)

- Hale Avenue (Sewer):
 - Hale Avenue is in very poor condition (PCI = 24)
 - Powell Street is in fairly good condition (PCI varies from 82 to 95)
 - Approximately 50 feet, curb-to-curb, Mill and Overlay of Powell Street is proposed with this project.
 - Hale Avenue is part of the COSA 2021 Street Maintenance/Pavement Rehabilitation Program
 - Replacement of sewer main in place (open-cut construction).
 - Pavement Restoration To Be Performed to as per SAWS Standard Detail DD-804-01
 - Trench to be restored with 10" Type B HMAC and 2" Type D HMAC
 - Removal & replacement of three (3) manholes, reconnection of one (1) lateral.
 - Sewer tie-in at Finton (unimproved)(Finton not labeled on plans) will require a SAWS approved adaptor.
 - Existing underground gas and water lines parallel to and crossing proposed sewer mains. Existing overhead electric / telecom along the project area.
 - CoSA Tree Permit
 - Applies to tree trimming where branches overhang onto street or are in conflict with existing/proposed utilities.
 - Trees in the vicinity of construction shall be protected in accordance with the City of San Antonio Tree Protection Details.
 - Tree trimming as necessary to facilitate construction is no separate pay item. Contractors should visit site before bidding.



Project Details (Package VI) – Hale Avenue

Pavement Condition Index

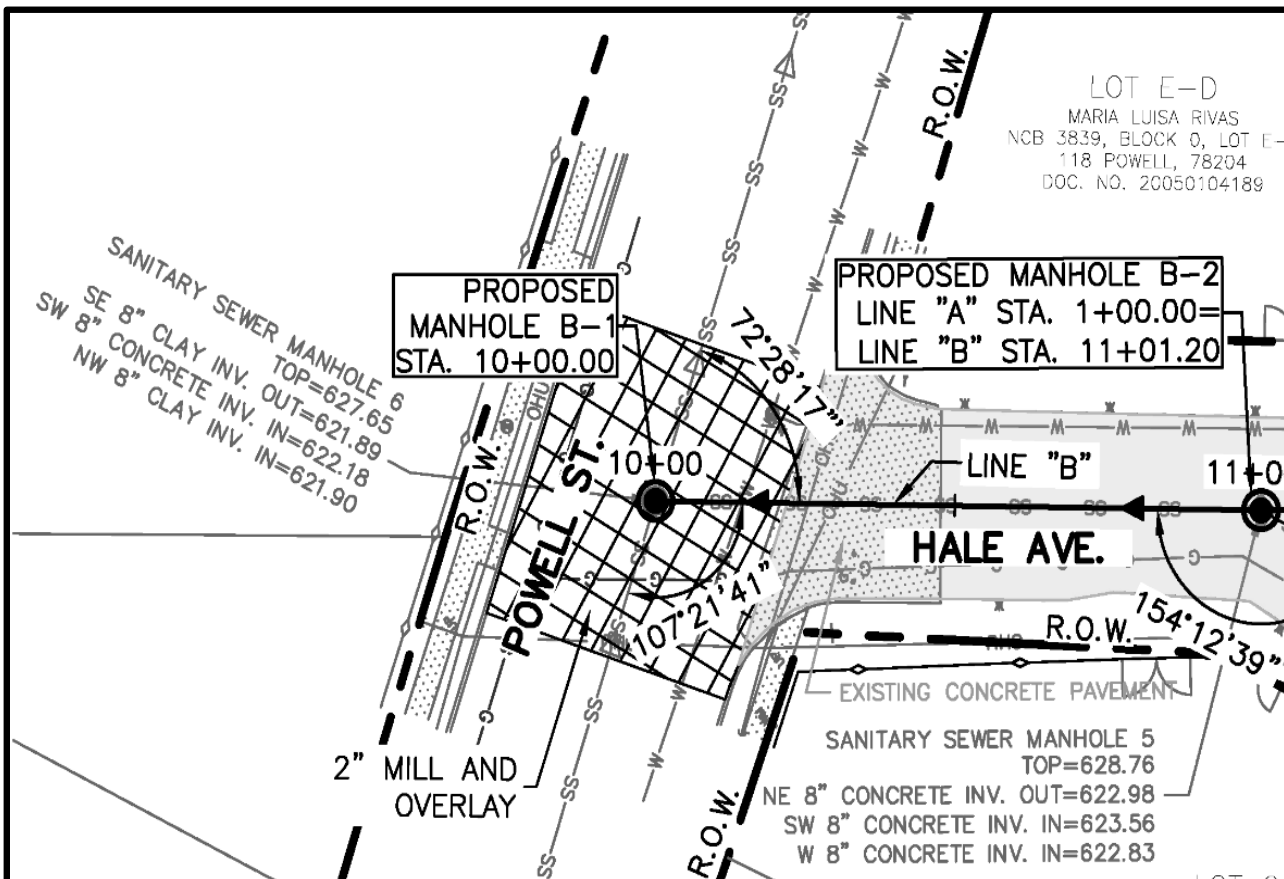

Project Details (Package VI)

• Hoover Avenue (Sewer):

- Hoover Avenue is in poor condition (PCI = 39) with alligator cracking throughout.
- Hoover Avenue is part of the COSA 2021 Street Maintenance/Pavement Rehabilitation Program
- Replacement of sewer main in place (open-cut construction).
 - Pavement Restoration To Be Performed to as per SAWS Standard Detail DD-804-01
 - Trench to be restored with 10" Type B HMA and 2" Type D HMA
- Removal & replacement of three (5) manholes, reconnection of forty-one (41) laterals.
- Higher rated pressure pipe (minimum 150 p.s.i.) required at water crossings.
- Existing underground gas and water lines parallel to and crossing proposed sewer main.
- Existing overhead electric /telecom along entire project.
- Variance letters will be submitted for sewer main segments below TCEQ minimum required slopes.

– CoSA Tree Permit

- Applies to tree trimming where branches overhang onto street or are in conflict with existing/proposed utilities.
- Trees in the vicinity of construction shall be protected in accordance with the City of San Antonio Tree Protection Details.
- Tree trimming as necessary to facilitate construction is no separate pay item. Contractors should visit site before bidding.

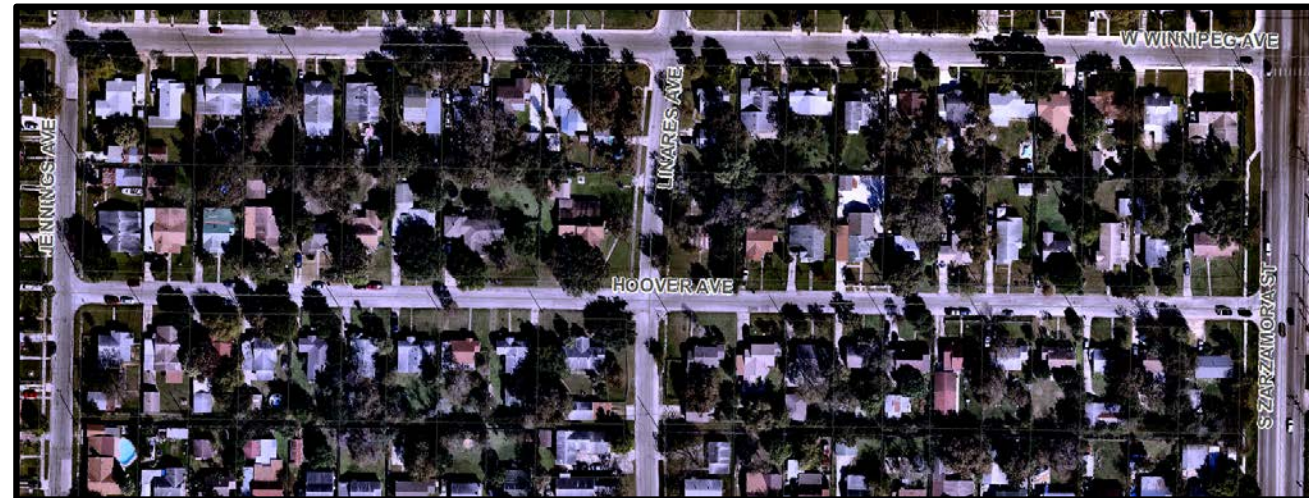

Project Details (Package VI)

• Hoover Avenue (Water):

- Hoover Avenue is in poor condition (PCI = 39) with alligator cracking throughout.
- Hoover Avenue is part of the COSA 2021 Street Maintenance/Pavement Rehabilitation Program
- New water main alignment (open-cut construction), abandonment of existing water main.
 - Pavement Restoration To Be Performed to as per SAWS Standard Detail DD-804-01
 - Trench to be restored with 10" Type B HMA and 2" Type D HMA
 - Relay services with new meter boxes and reset meters at property lines.
- Removal and disposal of existing A.C. water main as required.
- Water mains to be encased with flowable fill where they are adjacent to sanitary sewer manholes.
- Existing underground gas and sewer lines parallel to and crossing proposed water main.
- Existing overhead electric /telecom along entire project.

– CoSA Tree Permit

- Applies to tree trimming where branches overhang onto street or are in conflict with existing/proposed utilities.
- Trees in the vicinity of construction shall be protected in accordance with the City of San Antonio Tree Protection Details.
- Tree trimming as necessary to facilitate construction is no separate pay item. Contractors should visit site before bidding.

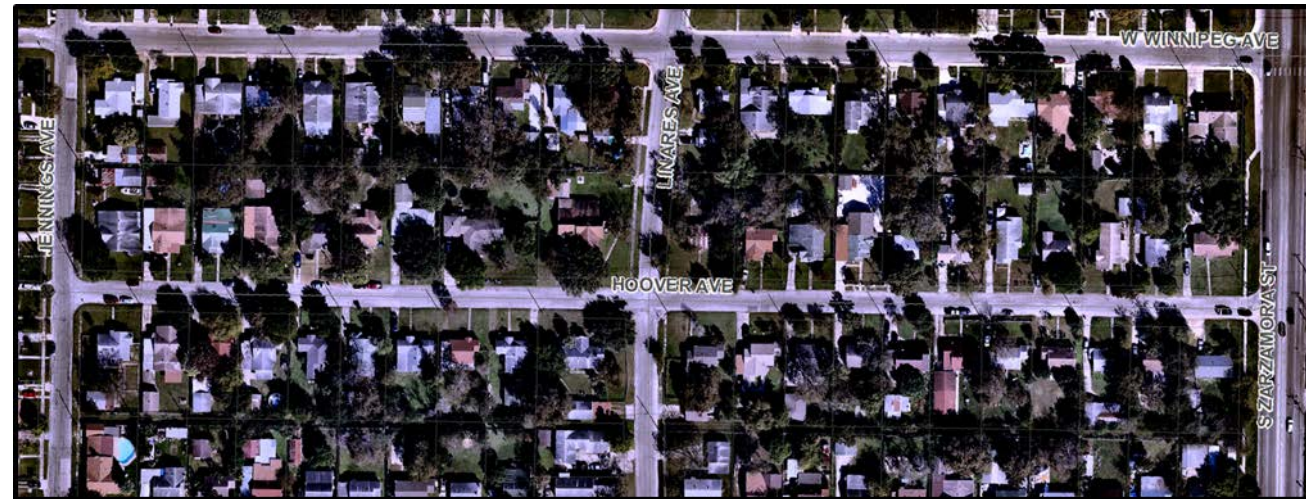

Project Details (Package VI)

- Kernan Drive (Water):

- Kernan Drive is in very poor condition (PCI = 22) with alligator cracking throughout.
- Kernan Drive is part of the COSA 2021 Street Maintenance/Pavement Rehabilitation Program
- New water main alignment (open-cut construction), abandonment of existing water main.
 - Pavement Restoration To Be Performed to as per SAWS Standard Detail DD-804-01
 - Trench to be restored with 10" Type B HMA and 2" Type D HMA
 - Relay services with new meter boxes and reset meters in existing location.
- Removal and disposal of existing A.C. water main as required.
- Existing underground gas and electric lines parallel to and crossing proposed water main.

- CoSA Tree Permit

- Applies to tree trimming where branches overhang onto street or are in conflict with existing/proposed utilities.
- Trees in the vicinity of construction shall be protected in accordance with the City of San Antonio Tree Protection Details.
- Tree trimming as necessary to facilitate construction is no separate pay item. Contractors should visit site before bidding.



QUESTIONS?

Reminder: Oral statements or discussion during the pre-bid meeting today will not be binding, nor will it change or affect the terms or conditions within the Plans and Specifications of this Project. Changes, if any, will be addressed in writing only via an Addendum.

2021 SMP Packages I, II, III, IV, V, & VI

Sirahuen Guajardo Jr., P.E.

Project Engineer

Efrain Aguirre, Graduate Eng II

Pipelines - Governmental

Florinda Gonzales

Interim Contract Administrator

Stella Manzello

Contract Administrator

Susan Rodriguez

SMWVB Program Specialist

Bryan Spina, P.E.

Project Engineer of Record

Greg Blackburn, P.E.

Project Engineer of Record

Chris Boentges, P.E.

Project Engineer of Record

Joseph Marranzino, P.E.

Project Engineer of Record



**San
Antonio
Water
System**

Non- Mandatory Pre-Bid Meeting

August 14, 2020

MAKING SAN ANTONIO
WATERFUL

